

ABP Architectural Coping for buildings of any height

TYPICAL ARCHITECTURAL COPING SECTION

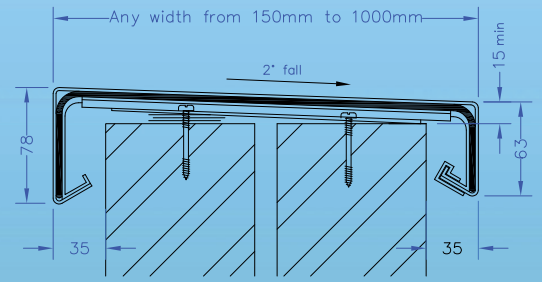

ABP ClickFix Coping for buildings upto 4 storeys

TYPICAL CLICKFIX COPING SECTION

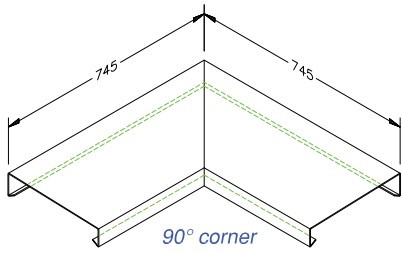
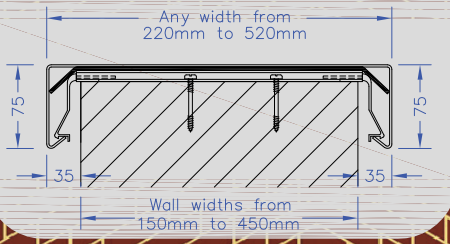

90° corner

Irregular Corner (other than 90° or different widths)

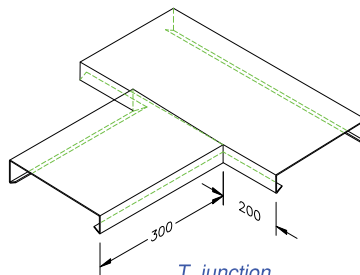

T junction

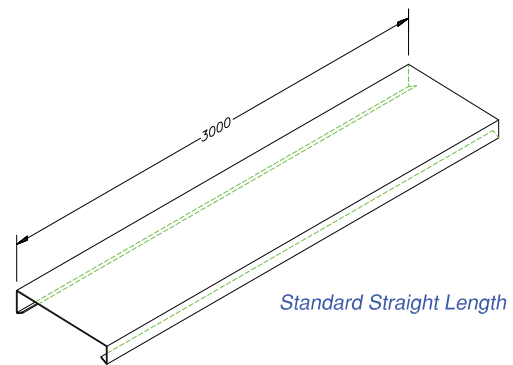

Standard Straight Length

Component lengths shown as 745mm but change to 995mm when width exceeds 500mm

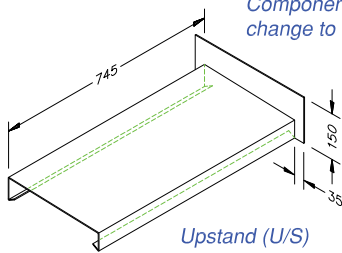

Upstand (U/S)

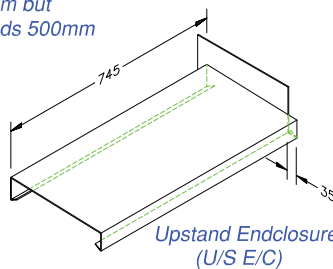

Upstand Enclosure (U/S E/C)

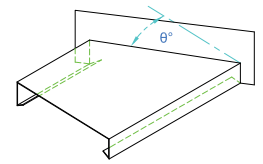

Angled Upstand

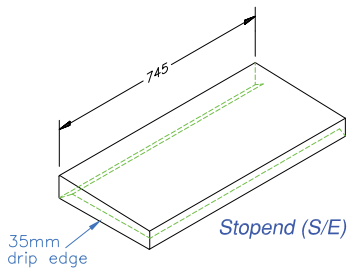

Stopend (S/E)

35mm drip edge

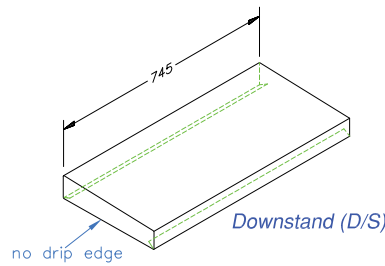

Downstand (D/S)

no drip edge

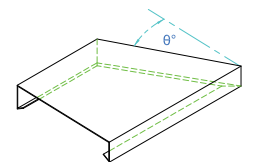

Angled Stopend

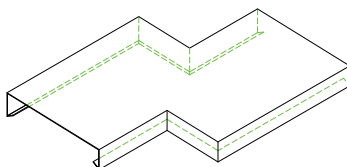

Zed Section

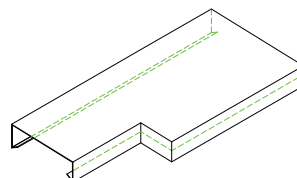

Reduction

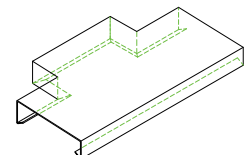

Pier